





CROWN GRAPHIC

MARKING SYSTEMS CATALOGUE

JANUARY 2008

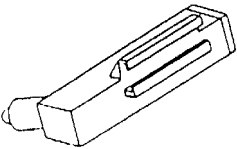
PAGE L01.01

Model	OEM Part	Our Equivalent	Pk	LAMBRECHT
HYGROGRAPH 250, THERMOGRAPH 252, METEOROGRAPH 253, FERN-THERMOGRAPH 256, 257, 258, 265, 290, 292, 293, 1507, 1509, 1517, 1521.	252-144 V 33.02520.14000	1SD6-V	6	
	252-144 R 33.02520.144010	1SD6-R	6	
	252-144 N 252-144 B 252-144 G	1SD6-N 1SD6-B 1SD6-G	6 6 6	
STRIP CHART RECORDER SERIES 1485.		1CY7-B02 1CY7-G02 1CY7-M02 1CY7-N02 1CY7-R02 1CY7-V02	6 6 6 6 6 6	

GRAPHIC CONTROLS LTD, ST PETERS QUAY, TOTNES, DEVON, TQ9 5XH, UK

TEL : +44 (0)1803 860100 FAX : +44 (0)1803 863838 EMAIL : sales@crowng.com WEB : http://www.crowng.com



CROWN GRAPHIC

MARKING SYSTEMS CATALOGUE

JANUARY 2008

PAGE L02.01

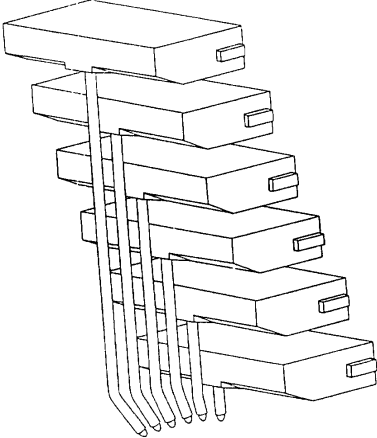
Model	OEM Part	Our Equivalent	Pk	LAUMANN
MULTICASSETTE RECORDER SERIES 6000, GILA 1000- 6000, MINIKAS 122, 124, MINI 121N, 121B, SERVOKASS 200, 600, DLH 2000, DLN 200, 252N, MINI 220, 220N.	26041 (SHORT)	1MT231-V	2	
	26042	1MT232-R	2	
	26043	1MT233-N	2	
	26044	1MT234-G	2	
	26045	1MT235-B	2	
	26046 (LONG)	1MT236-M	2	

GRAPHIC CONTROLS LTD, ST PETERS QUAY, TOTNES, DEVON, TQ9 5XH, UK

TEL : +44 (0)1803 860100 FAX : +44 (0)1803 863838 EMAIL : sales@crowng.com WEB : http://www.crowng.com

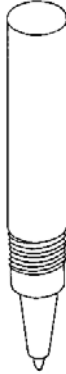

Model	OEM Part	Our Equivalent	Pk	LAUMONIER
		1MT291-B	1	
<p>THE CY1 FTD PEN RANGE IS AVAILABLE IN A VARIETY OF COLOURS, EITHER A,B,C,G,M,N,O,R,V OR Y.</p>		1CY1-#01	3	
		1CY1P3-#01	3	
		1CY1P5-#01	3	
		1CY1P7-#01	3	
		1CY1RB-#01	3	

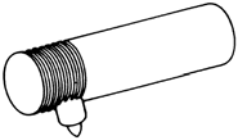
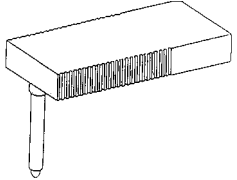

Model	OEM Part	Our Equivalent	Pk	LDC LATEK
	3100 3200	1PB3-N03 1PB3-R03	5 5	
	3401-2 3402	1FD29C31-R 1FD29C09-N	5 5	

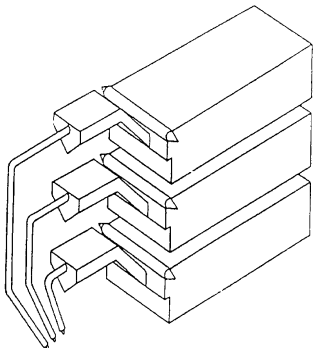
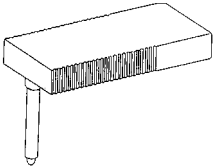
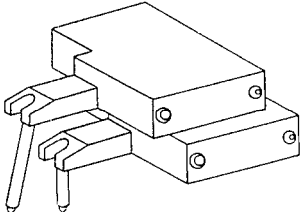

Model	OEM Part	Our Equivalent	Pk	LEEDS & NORTHRUP
SPEEDOMAX 400 CAPILLARY RECORDER.	054261	4N38X2 TIP	1	
	122086 122212	2N200A-G	4	
	122100 122211	2N200A-R	4	
	122101 122213	2N200A-B	4	
	122215 SLOW DRY	2N200A-R03	4	
	122216 SLOW DRY	2N200A-B03	4	
	122217 SLOW DRY	2N200A-G03	4	
IF YOU REQUIRE A FTD PEN FOR THE RECORDER, SEE BELOW.				
SPEEDOMAX SERIES 400, TYPE 401, TYPE 402, TYPE 403, SPEEDOMAX SERIES 430, TYPE 431, TYPE 432, TYPE 433.	018500 125233	1MT091-R	3	
	018501 125234	1MT092-B	3	
	018502 125235	1MT093-G	3	
SP 500 SERIES	054366	1FD29C07-R	5	
SPEEDOMAX 165, 250.	020724 (SHORT)	1FD30-B	3	
	020723 (LONG)	1FD31-R	3	

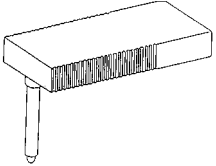
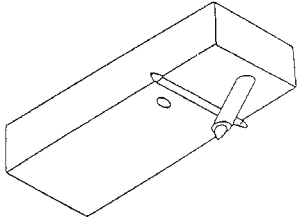
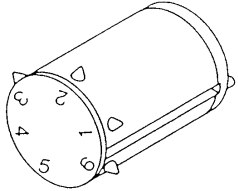

Model	OEM Part	Our Equivalent	Pk	LEEDS & NORTHRUP
	054042	9PRLN	1	
	054141	4LN-2-312-46	1	
	054213	9LN01 JEWEL PEN ASSY.	1	
	054265	9LN02 JEWEL PEN ASSY.	1	
SPEEDOMAX H (MODEL R 50,000 SERIES) ROUND RECORDERS.	125069	2N300-N	4	
SPEEDOMAX H & W MODEL S MANUFACTURED BEFORE APRIL '68	054366	1FD29C07-R	5	
MANUFACTURED AFTER APRIL '68.	054190 054191 054192	1SD33-R 1SD33-B 1SD33-N	5 5 5	
SPEEDOMAX 1000 - MODEL 116.	080604	6PW01	1	

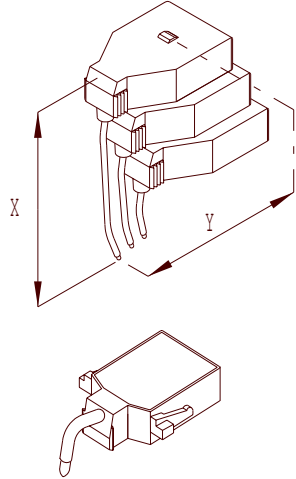
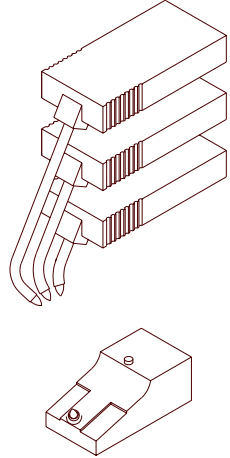
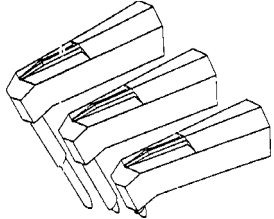

Model	OEM Part	Our Equivalent	Pk	LEEDS & NORTHRUP
MODELS 101, 102, 103, 111, 112, 113.	080600	1MT911-B	1	
	080601	1MT912-R	1	
	080602	1MT913-G	1	
	080603	1MT91A-V	1	
SPPEDOMAX AL HYBRID.	22019-425301	1MT951-R	3	
	22019-425302	1MT952-G	3	
	22019-425303	1MT953-B	3	
	22015-426201	1MT95A-N	5	
MODEL 201, MODEL 202, MODEL 203.	075800	1FD341-R	5	
	075801	1FD342-G	5	
	075802	1FD343-B	5	



Model	OEM Part	Our Equivalent	Pk	LEEDS & NORTHRUP
SPEEDOMAX 210	081358	1UD231-B	2	
	081359	1UD232-R	2	
	081360	1UD233-G	2	
	081361	1UD234-N	2	
SPEEDOMAX 100	041392	1FD321-R	3	
	041393	1FD322-B	3	
	041394	1FD323-G	3	
<p>SERIES 04, U15 AND U20 CIRCLE CHART RECORDERS CONVERTED TO FTD PENS WITH A SLIDE ON ARM, CAN USE OUR 1UD20 SERIES PENS. PLEASE CONTACT OUR SALES DEPT. FOR DETAILS.</p>				
	054040	9PE01	1	
<p>TO CONVERT THE RECORDER TO FTD PENS USE THE ARM AND FTD PEN LISTED BELOW.</p>				
	054040	9KPB21 1PB21-R	1 1	



Model	OEM Part	Our Equivalent	Pk	LEEDS & NORTHRUP	
FELT PAD INK. STD INK	125167	3CC50-B01			
	125186	3CC50-B01			
	125169	3CC50-G01			
	125166	3CC50-R01			
	125187	3CC500-G01			
	125104	3CC500-N01			
	125010	3CC500-R01			
	125185	3CC500-R01			
	125180	3OZ4-R01			
	125189	3OZ8-B01			
	125063	3OZ8-R01			
	125188	3OZ8-R01			
	QUICK DRY.	111059	3CC50-B02		
		125113	3CC50-B02		
125114		3CC50-G02			
122022		3CC50-N02			
125055		3CC50-N02			
125051		3CC50-R02			
125059		3CC50-V02			
125124 125045		3CC500-B02 3CC500-R02			
125060	3OZ8-R02				
SLOW DRY.	125143	3CC50-B03			
	125147	3CC50-G03			
	125133	3CC50-R03			
	125141	3CC500-B03			
	125142	3CC500-G03			
	125149	3CC500-R03			
	125144	3OZ8-B03			
	125148	3OZ8-G03			
	125135	3OZ8-R03			

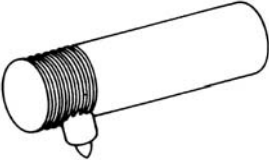

Model	OEM Part	Our Equivalent	Pk	LEEDS & NORTHRUP
PAD INK.	125015 125016 125017 125018 125019 125021 125022	3LNPADB15 3LNPADG15 3LNPADO15 3LNPADR15 3LNPADV15 3LNPADN15 3LNPADM15	1 1 1 1 1 1 1	
SPEEDOMAX XL/681A	19100.A16 12700 E85	1PB3-R07	5	
SPEEDOMAX XL682.	19100.A17 12700 E86 19100.A16 12700 E85	1PB3-B06 1PB3-R07	5 5	



CROWN GRAPHIC

MARKING SYSTEMS CATALOGUE

JANUARY 2008

PAGE L06.01

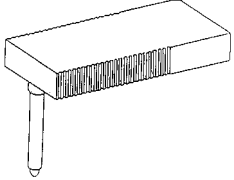
Model	OEM Part	Our Equivalent	Pk	LEOPOLD SYBRON
CIRCULAR CHART RECORDERS.	187-08968 (QD) 187-08969 (QD) 187-09875 187-09876	2N300-R02 2N300-G02 2N300-R 2N300-G	4 4 4 4	
A-71 TYPE F, 61R, 88R.	25387 34893	1FD29C24-B	5	

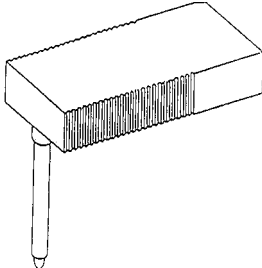
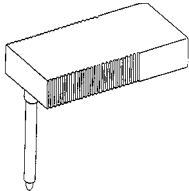

Model	OEM Part	Our Equivalent	Pk	LINEAR
140, 141, 142, 143, 255, 285, 355, 361, 395, 412, 455, 456, 555, 701, 1101, 1201, 1210.	0100-0105 16840	1FD29C09-B	5	
	0100-0106 PR32 16832	1FD29C09-R	5	
	0100-0107 PR30 16830	1FD29C09-N	5	
	0100-0108	1FD29C09-G	5	
232, 281, 282, 284, 285-14, 290, 291, 294, 385, 391, 345, 422, 432, 485, 486, 585, 595, 1202.	0100-0105 16840	1FD29C09-B	5	
	0100-0106 PR32 16832	1FD29C09-R	5	
	0100-0107 PR30 16830	1FD29C09-N	5	
	0100-0108	1FD29C09-G	5	
	0100-0109 PR36 16836	1FD29C31-B	5	
	0100-0110	1FD29C31-R	5	
	0100-0111	1FD29C31-N	5	
	0100-0112 PR-35 16835	1FD29C31-G	5	
355, 395, 595.	0100-0105	1FD29C09-B	5	
	0100-0131 16841	1FD29C26-N	5	
	0100-0132 16842	1FD29C38-G	5	



CROWN GRAPHIC

MARKING SYSTEMS CATALOGUE

JANUARY 2008

PAGE L07.02

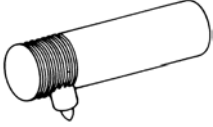
Model	OEM Part	Our Equivalent	Pk	LINEAR
112, 152, 155, 156, 160, 161, 212, 222, 252, 252A, 254, 255-14, 260, 261, 264.	0100-0101 PR-16 16816	1PB3-B03	5	
	0100-0102 PR-12 16812	1PB3-R03	5	
	0100-0103 PR-10 16810	1PB3-N03	5	
	0100-0104 PR-15 16815	1PB3-G03	5	

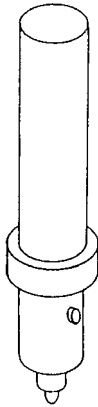
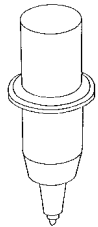

Model	OEM Part	Our Equivalent	Pk	LINEAR GRAPHICS
PLOTMATE A4M, PLOTMATE A3M SINGLE PEN PLOTTER 1200-005.	1250-002	1CY14P3-N	5	
	1250-003	1CY14P3-R	5	
		1CY14P3-A	5	
		1CY14P3-B	5	
		1CY14P3-C	5	
		1CY14P3-G	5	
		1CY14P3-M	5	
	1CY14P3-O	5		
	1CY14P3-V	5		
	1CY14P3-Y	5		
	1250-051	1CY14P3MIX05 MOAYCRBGNV	10	
	1250-006	1CY14P7MIX07 RBGNVM	6	
	1250-053	1CY14RB-N	5	
	1250-005	1CY14RBMIX07 RBGNVM	6	
<p>AS WELL AS SUPPLYING MIXED PACKS WE CAN SUPPLY PACKS IN SINGLE COLOURS, AS WELL WE CAN SUPPLY CY14'S WITH A P5 TIP. THE COLOURS AVAILABLE ARE A,B,C,G,M,N,O,R,V OR Y.</p>				
PLOTMATE A3M MULTI PEN PLOTTER 1205-105.	1250-083	1CY20P3-N	5	
	1250-084	1CY20P3-R	5	
	1250-085	1CY20P3-B	5	
	1250-081	1CY20P3MIX05 MOAYCRBGNV	10	
<p>WE CAN SUPPLY THE FULL RANGE OF COLOURS IN THE P3 RANGE AS WELL AS OFFERING EITHER A P5, P7 OR RB TIP OPTION. THE COLOURS AVAILABLE ARE EITHER A,B,C,G,M,N,O,R,V OR Y.</p>				

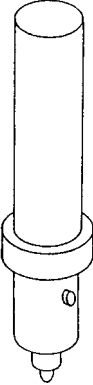

Model	OEM Part	Our Equivalent	Pk	LINSEIS
LY/18PL, LY1500, LY1600.	80116023 LY/HP01	1CY14P3-G	5	
	80116024 LY/HP02	1CY14P3-R	5	
	80116025 LY/HP05	1CY14P3-N 1CY14P3-A 1CY14P3-B 1CY14P3-C 1CY14P3-M 1CY14P3-O 1CY14P3-V 1CY14P3-Y	5 5 5 5 5 5 5	
	80116020 LY/HP11	1CY14RB-G	5	
	80116021 LY/HP12	1CY14RB-R	5	
	80116022 LY/HP15	1CY14RB-N	5	
	1CY14RB-A 1CY14RB-B 1CY14RB-C 1CY14RB-M 1CY14RB-O 1CY14RB-V 1CY14RB-Y	5 5 5 5 5 5 5	5 5 5 5 5 5 5	

WE CAN ALSO OFFER A P5 OR P7 TIP TYPE OF THE CY14 FTD PEN SERIES. FOR THE AVAILABLE COLOURS REFER TO THE RB LISTING ABOVE.

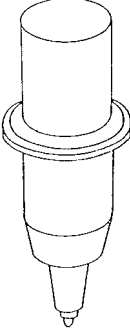
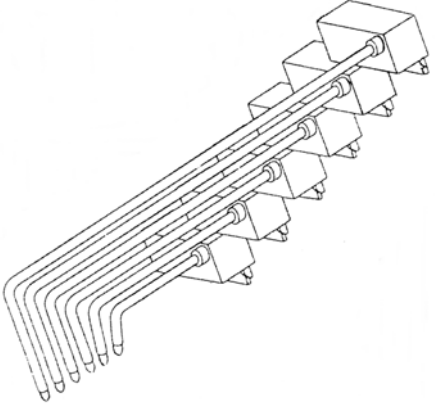

Model	OEM Part	Our Equivalent	Pk	LINSEIS
XY-RECORDERS LY1400, LY1500, LY1600, LY1900PL, PLF1620, PLT1600/LPT A-0, PLT1610/LPT A-1.	80116026	1CY20P3-B	5	
	80116027	1CY20P3-N	5	
	80116028	1CY20P3-G	5	
	80116029	1CY20P3-B	5	
	80116030	1CY20P3-V	5	
	80116031	1CY20P3-O	5	
	80116032	1CY20P3-Y	5	
	80116033	1CY20P3-M	5	
		1CY20P3-A	5	
		1CY20P3-C	5	
<div style="border: 1px solid black; padding: 5px; width: fit-content; margin: 0 auto;"> <p>WE CAN ALSO OFFER A P5, P7 AND A RB TIP TYPE OF THE CY20 PEN SERIES. FOR THE COLOURS AVAILABLE PLEASE REFER TO THE P3 LIST ABOVE.</p> </div>				
LM11, LM211, LS24, LS44, LS46.	LO/2015 LO/21	1MT031-G	2	
	LO/2205 LO/22	1MT032-R	2	
LS3, LS4, LS52, LM23, LM24, LS25, LS45, LS51, LS65, L601, L651, L652, L6010, L6012, L6510, L6512, L6514, L6520, L6522.	LO/211 LO/212 LO/21	1MT031-G	2	
	LO/221 LO/222 LO/22	1MT032-R	2	
	LO/231 LO/232 LO/23	1MT033-B	2	
	LO/241 LO/242 LO/24	1MT034-M	2	
	LO/251 LO/252 LO/25	1MT035-N	2	
	LO/261 LO/262 LO/26	1MT036-V	2	



Model	OEM Part	Our Equivalent	Pk	LINSEIS
L1000	LO/01 LO/1	1MT041-G	1	
	LO/02 LO/2	1MT042-R	1	
SERIES 2000, 2001, 2005, 7000, 7005, 7105. L2000, L2020, L2040, L2060, LY8222 Z, LY8222 ZPA, LY722 Z, 800 XY, 800 XY-Y, L2021, L2025, L2041, L2045, L2061, L2020, L7025, L7040, L7045, L7060, L7065, L7125, L7145, L7165, L7720, L7740, L1000.	LO/01 LO/1	1MT041-G	1	
	LO/02 LO/2	1MT042-R	1	
	LO/03 LO/3	1MT043-B	1	
	LO/04 LO/4	1MT044-M	1	
	LO/05 LO/5	1MT045-N	1	
	LO/06 LO/6	1MT046-V	1	
L2001Y, L2025, L2045, L2065, L7005, L7025, L7045, L7065, L7100, L7620, L7640, L7720, L7740.	L2001/1	1MT041V-G	1	
	L2001/2	1MT042V-R	1	
	L2001/3	1MT043V-B	1	
	L2001/4	1MT044V-M	1	
	L2001/5	1MT045V-N	1	
	L2001/6	1MT046V-V	1	
L300, L600, L650	LM300/1 LM300/2	1MT051-G 1MT052-R	1 1	



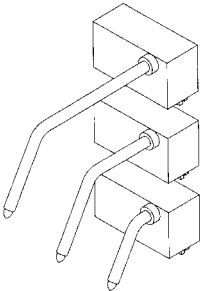

Model	OEM Part	Our Equivalent	Pk	LINSEIS
L6010, L6510, L6514, L6520, L6522, L6622.	L651/1 L651/2 L651/3 L651/4	1MT0511-G 1MT0521-R 1MT0531-B 1MT0541-M	1 1 1 1	
LY700, LY1700, LY800, LY1800, LY7222Z, LY1722T, LY1822Z, LY17100, LY17200, LY18100, LY18222Z.	LO/411 SHORT LO/412 LO/415 LO/421 LONG LO/422 LO/425	1MT0411-G 1MT0411-R 1MT0411-N 1MT0425-G 1MT0425-R 1MT0425-N	2 2 2 2 2 2	
LS6512	LS/210 LS/220 LS/230 LS/240	1MT821-G 1MT822-R 1MT823-B 1MT824-M	5 5 5 5	
	NT/111 NT/112 NT/113 NT/114 NT/115 NT/116	3CC100-G 3CC100-R 3CC100-B 3CC100-M 3CC100-N 3CC100-V	1 1 1 1 1 1	



Model	OEM Part	Our Equivalent	Pk	LLOYD INSTRUMENTS
CR450, G450X.	PNH/0220	1CY19-N	5	
CR100, CR500, PL3, PL50, PL100.	PNH/0008 PNH/0009 PNH/0010 PNH/0011	1CY19-R 1CY19-G 1CY19-N 1CY19-B	5 5 5 5	
G1000, G1002, G2000, G2002.	PNH/0146 PNH/0147 PNH/0148 PNH/0149 PNH/0141 PNH/0142 PNH/0143 PNH/0144	1MT681-N03 1MT681-R03 1MT681-G03 1MT681-B03 1MT682-N03 1MT682-R03 1MT682-G03 1MT682-B03	1 1 1 1 1 1 1 1	
STD SPEED PENS	PNH/0184 PNH/0185 PNH/0186 PNH/0187 PNH/0180 PNH/0181 PNH/0182 PNH/0183	1MT681-N04 1MT681-R04 1MT681-G04 1MT681-B04 1MT682-N04 1MT682-R04 1MT682-G04 1MT682-B04	1 1 1 1 1 1 1 1	
SLOW SPEED PENS	<p>DUE TO THE WIDE VARIATIONS IN CHART SPEEDS, WE HAVE DEVELOPED TWO RANGES OF PENS. THE SLOW SPEED PENS HAVE AN OPERATING RANGE OF 0.1mm PER MINUTE TO 600mm PER MINUTE. THE STD PENS HAVE AN OPERATING RANGE OF 1.0mm PER MINUTE TO 600mm PER SECOND.</p>			

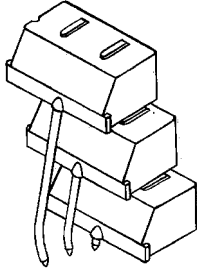

Model	OEM Part	Our Equivalent	Pk	LLOYD INSTRUMENTS
PL1000, PL1500, PL2000, PL2500, PL3000, CR800.	PNX/0034/00	1MT221-N	1	
	PNX/0033/07	1MT222-V	1	
	PNX/0032/02	1MT223-R	1	
	CLX/0045/00	9K220	10	
CR452 A, CR650, PL4, PL5, PL51, PL3, PL200, PD4, CR650S, CR652S.	PNH/0012	1CY4-N	5	
	PNH/0174	1CY4-R	5	
	PNH/0172	1CY4-B	5	
	PNH/0173	1CY4-G	5	
CR552, CR600, CR652, CR700, CR800.	PNH/0012	1CY4-N	5	
	PNH/0174	1CY4-R	5	
	PNH/0172	1CY4-B	5	
	PNH/0173	1CY4-G	5	
	PNH/0013	1CY18-R	5	
	PNH/0027	1CY18-G	5	



CROWN GRAPHIC

MARKING SYSTEMS CATALOGUE

JANUARY 2008

PAGE L11.01

Model	OEM Part	Our Equivalent	Pk	LODE
SPIROGRAPH D-75.		1CY8-B 1CY8-G 1CY8-N 1CY8-R	6 6 6 6	

GRAPHIC CONTROLS LTD, ST PETERS QUAY, TOTNES, DEVON, TQ9 5XH, UK

TEL : +44 (0)1803 860100 FAX : +44 (0)1803 863838 EMAIL : sales@crowng.com WEB : http://www.crowng.com